

SECTION B-B

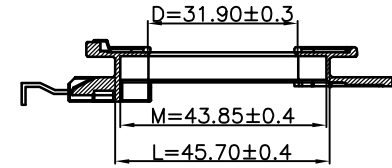
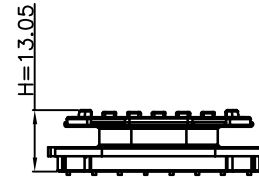
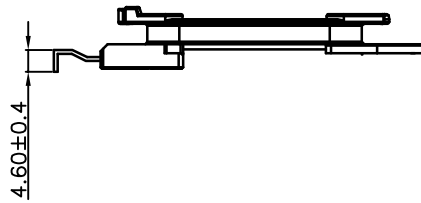
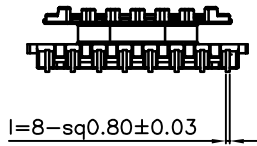
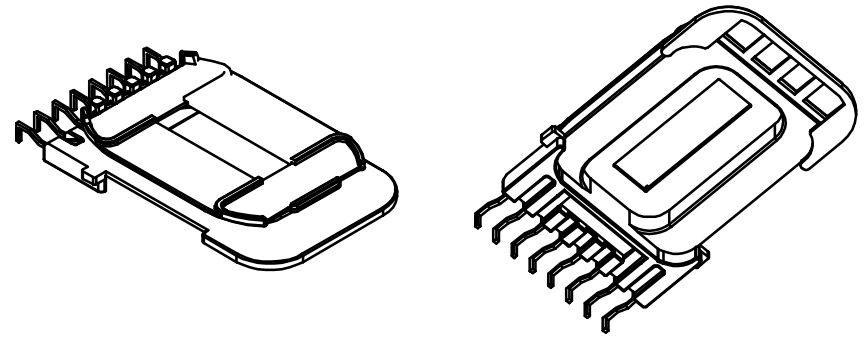
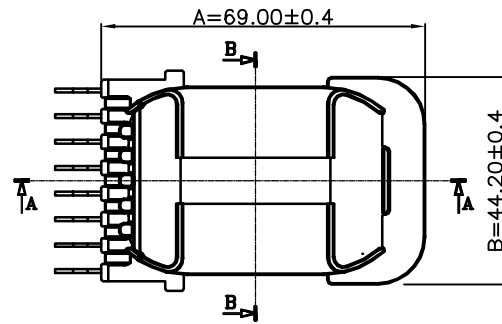

SECTION A-A

조립 부위 c값 변경 1.00mm*0.5mm -> 0.5mm*0.5mm

파손으로 인한 살부강 바닥에서 높이 0.7mm

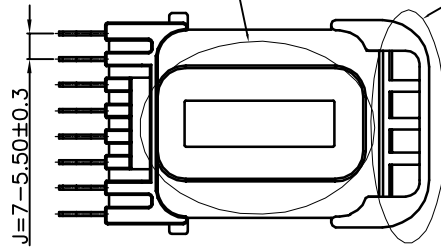

▲							
▲							
▲							
▲							
MARK	REVISION NOTE			DATE	DRAWN	CHECKED	APPROVED
DRAWN	CHECKED	APPROVED	MATERIAL : PHENOL	UL REC. : UL94V-0	THIRD ANGLE PROJ.	SCALE : 1/1	
GM, Joon	IM, Seo	C, Park	Z : PIN LENGTH (According to customer's request)	DATE : 2014.10.27	TOLERANCE : ±0.2 (Unless otherwise specified)	UNIT : m/m	
주식회사 대흥보빈 DAE HEUNG BOBBIN CO., LTD			TITLE EE 48*13 "V" (8P) HOOK		DWG NO DH-141227-2068-14		